

S P S

The SPS product family is specially designed for an off-line SMPS with minimal external components. The SPS consist of high voltage power SenseFET and current mode PWM IC.

Included PWM controller features integrated fixed oscillator, under voltage lock out, leading edge blanking, optimized gate turn-on/turn-off driver, thermal shut down protection, over voltage protection, and temperature compensated precision current sources for loop compensation and fault protection circuitry. Compared to discrete MOSFET and controller or RCC switching converter solution, a SPS can reduce total component count, design size, and weight and at the same time increase efficiency, productivity, and system reliability. It has a basic platform well suited for cost-effective design in Quasi-Resonant Converter as C-TV power supply.

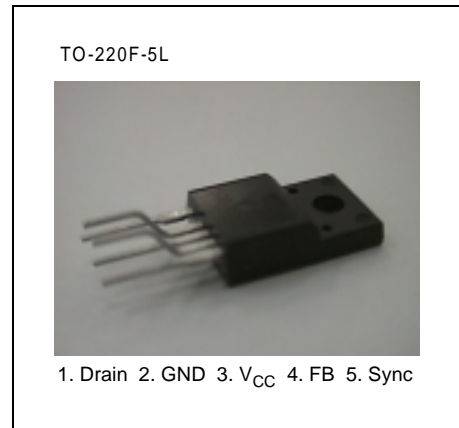

FEATURES

- Quasi Resonant Converter Controller
- Internal Burst mode Controller for Stand-by mode
- Pulse by pulse current limiting
- Over current Latch protection
- Over voltage protection (V<sub>sync</sub>: Min. 11V)
- Internal thermal shutdown function
- Under voltage lockout
- Internal high voltage sense FET
- Auto-restart mode

ORDERING INFORMATION

Device	Package	Topr (°C)
KA5Q0765RT	TO-220F-5L	-25°C to +85°C

BLOCK DIAGRAM

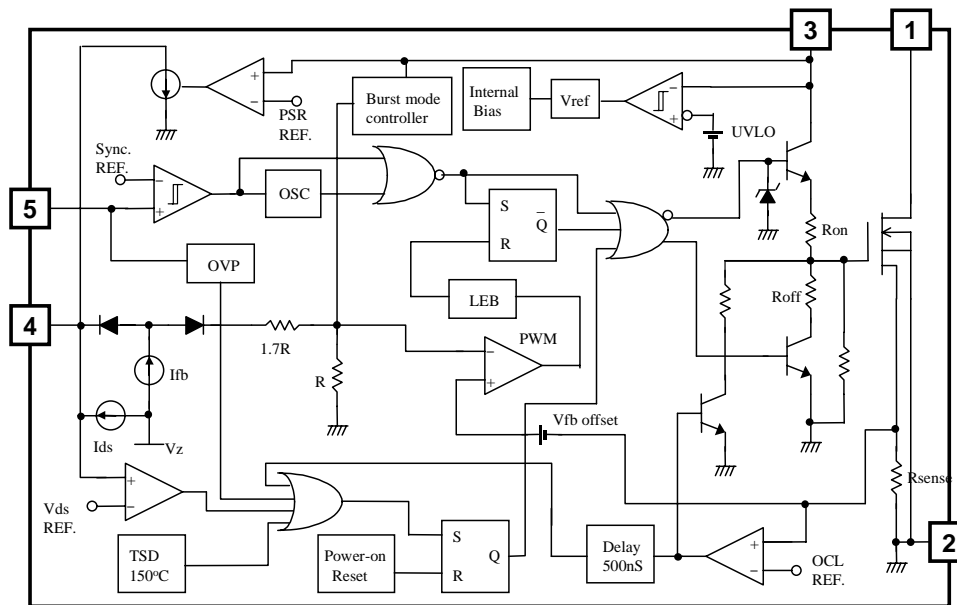

## ABSOLUTE MAXIMUM RATINGS

Characteristic	Symbol	Value	Unit
Drain-source (GND) voltage <sup>(1)</sup>	V <sub>DSS</sub>	650	V
Drain-Gate voltage (R <sub>GS</sub> =1MΩ)	V <sub>DGR</sub>	650	V
Gate-source (GND) voltage	V <sub>GS</sub>	±30	V
Drain current pulsed <sup>(2)</sup>	I <sub>DM</sub>	28.0	A <sub>DC</sub>
Single pulsed avalanche energy <sup>(3)</sup>	E <sub>AS</sub>	570	mJ
Avalanche current <sup>(4)</sup>	I <sub>AS</sub>	20	A
Continuous drain current (T <sub>C</sub> =25°C)	I <sub>D</sub>	7.0	A <sub>DC</sub>
Continuous drain current (T <sub>C</sub> =100°C)	I <sub>D</sub>	5.6	A <sub>DC</sub>
Supply voltage	V <sub>CC</sub>	30	V
Analog input voltage range	V <sub>FB</sub>	-0.3 to V <sub>SD</sub>	V
Total power dissipation	P <sub>D</sub> (wt H/S)	135	W
	Derating	1.1	W/°C
Operating temperature	T <sub>OPR</sub>	-25 to +85	°C
Storage temperature	T <sub>STG</sub>	-55 to +150	°C

## NOTES:

1. T<sub>j</sub>=25°C to 150°C
2. Repetitive rating: Pulse width limited by maximum junction temperature
3. L=24mH, starting T<sub>j</sub>=25°C
4. L=13uH, starting T<sub>j</sub>=25°C

**ELECTRICAL CHARACTERISTICS (SFET part)**

(Ta=25°C unless otherwise specified)

Characteristic	Symbol	Test condition	Min.	Typ.	Max.	Unit
Drain-source breakdown voltage	$BV_{DSS}$	$V_{GS}=0V, I_D=50\mu A$	650	–	–	V
Zero gate voltage drain current	$I_{DSS}$	$V_{DS}=\text{Max.}, \text{Rating}, V_{GS}=0V$	–	–	200	$\mu A$
		$V_{DS}=0.8\text{Max.}, \text{Rating}, V_{GS}=0V, T_C=125^\circ C$	–	–	500	$\mu A$
Static drain-source on resistance <sup>(note)</sup>	$R_{DS(ON)}$	$V_{GS}=10V, I_D=4.0A$	–	1.25	1.6	$\Omega$
Forward transconductance <sup>(note)</sup>	gfs	$V_{DS}=15V, I_D=4.0A$	3.0	–	–	S
Input capacitance	$C_{iss}$	$V_{GS}=0V, V_{DS}=25V, f=1\text{MHz}$	–	1600	–	$\mu F$
Output capacitance	$C_{oss}$		–	310	–	
Reverse transfer capacitance	$C_{rss}$		–	120	–	
Turn on delay time	td(on)	$V_{DD}=0.5BV_{DSS}, I_D=7.0A$ (MOSFET switching time are essentially independent of operating temperature)	–	25	–	nS
Rise time	tr		–	55	–	
Turn off delay time	td(off)		–	80	–	
Fall time	tf		–	50	–	
Total gate charge (gate-source+gate-drain)	Qg	$V_{GS}=10V, I_D=7.0A, V_{DS}=0.5BV_{DSS}$ (MOSFET switching time are essentially independent of operating temperature)	–	–	72	nC
Gate-source charge	Qgs		–	9.3	–	
Gate-drain (Miller) charge	Qgd		–	29.3	–	

**NOTE:** Pulse test: Pulse width  $\leq 300\mu S$ , duty cycle  $\leq 2\%$

**ELECTRICAL CHARACTERISTICS (Control part)**

(Ta=25°C unless otherwise specified)

Characteristic	Symbol	Test condition	Min.	Typ.	Max.	Unit
<b>SENSE FET SECTION</b>						
Drain to PKG Breakdown voltage	BVpkg	60Hz AC, Ta=25°C	3500	–	–	V
Drain to Source Breakdown voltage	BVdss	Vdrain=650V, Ta=25°C	650	–	–	V
Drain to Source Leakage current	Idss	Vdrain=650V, Ta=25°C	–	–	200	µA
<b>OSCILLATOR SECTION</b>						
Initial Frequency	F <sub>OSC</sub>	–	18	20	22	KHz
Voltage Stability	F <sub>STABLE</sub>	12≤V <sub>CC</sub> ≤23V	0	1	3	%
Temperature Stability <sup>note 2</sup>	ΔF <sub>OSC</sub>	-25°C≤Ta≤85°C	0	±5	±10	%
Maximum Duty Cycle	D <sub>MAX</sub>	–	92	95	98	%
Minimum Duty Cycle	D <sub>MIN</sub>	–	–	–	0	%
<b>UVLO SECTION</b>						
Start Threshold Voltage	V <sub>START</sub>	V <sub>FB</sub> =GND	14	15	16	V
Stop Threshold Voltage	V <sub>STOP</sub>	V <sub>FB</sub> =GND	8	9	10	V
<b>FEEDBACK SECTION</b>						
Feedback Source Current	I <sub>FB</sub>	V <sub>FB</sub> =GND	0.7	0.9	1.1	mA
Shutdown Feedback Voltage	V <sub>SD</sub>	V <sub>fb</sub> ≥6.9V	6.9	7.5	8.1	V
Shutdown Delay Current	I <sub>DELAY</sub>	V <sub>FB</sub> =5V	4	5	6	µA
<b>PROTECTION SECTION</b>						
Over Current Protection	V <sub>OVP</sub>	V <sub>sync</sub> ≥11V	11	12	13	V
Over Current Latch Voltage <sup>note 2</sup>	V <sub>OCL</sub>	–	0.9	1.0	1.1	V
Thermal shutdown Temp.	TSD	–	140	160	–	°C
<b>SYNC SECTION</b>						
Normal Sync High Threshold Voltage	V <sub>NSH</sub>	V <sub>CC</sub> =16V, V <sub>fb</sub> =5V	4.0	4.6	5.2	V
Normal Sync Low Threshold Voltage	V <sub>NSL</sub>	V <sub>CC</sub> =16V, V <sub>fb</sub> =5V	2.3	2.6	2.9	V
Burst High Threshold Voltage	V <sub>BSH</sub>	V <sub>CC</sub> =10.5V, V <sub>fb</sub> =0V	3.2	3.6	4.0	V
Burst Low Threshold Voltage	V <sub>BSL</sub>	V <sub>CC</sub> =10.5V, V <sub>fb</sub> =0V	1.1	1.3	1.5	V

**ELECTRICAL CHARACTERISTICS (Continued)**

(Ta=25°C unless otherwise specified)

Characteristic	Symbol	Test condition	Min.	Typ.	Max.	Unit
<b>BURST MODE SECTION</b>						
Burst mode Low Threshold Voltage	V <sub>BURL</sub>	V <sub>fb</sub> =0V	10.4	11.0	11.6	V
Burst mode High Threshold Voltage	V <sub>BURH</sub>	V <sub>fb</sub> =0V	11.4	12.0	12.6	V
Burst mode Enable Feedback voltage	V <sub>BEN</sub>	V <sub>CC</sub> =10.5V	0.7	1.0	1.3	V
Burst mode Peak Current Limit	I <sub>BU_PK</sub>	V <sub>CC</sub> =10.5V	0.65	0.85	1.0	V
<b>PRIMARY SIDE REGULATION SECTION</b>						
Primary Regulation Threshold Voltage	V <sub>PR</sub>	I <sub>fb</sub> =700μA, V <sub>fb</sub> =4V	32.0	32.5	33.0	V
Primary Regulation Transconductance	G <sub>PR</sub>	–	2.0	2.6	–	mA/V
<b>CURRENT LIMIT (SELF-PROTECTION) SECTION</b>						
Peak Current Limit <sup>note 3</sup>	I <sub>PK</sub>	–	4.4	5.0	5.6	A
<b>START UP CURRENT</b>						
Start up Current	I <sub>START</sub>	V <sub>fb</sub> =GND, V <sub>CC</sub> =14V	–	0.1	0.2	mA
Operating Supply Current <sup>note 1</sup>	I <sub>OP</sub>	V <sub>fb</sub> =GND, V <sub>CC</sub> =16V	–	10	18	mA
	I <sub>OP(MIN)</sub>	V <sub>fb</sub> =GND, V <sub>CC</sub> =12V				
	I <sub>OP(MAX)</sub>	V <sub>fb</sub> =GND, V <sub>CC</sub> =28V				

**NOTE:**

1. These parameters, although guaranteed, are not 100% tested in production
2. These parameters, although guaranteed, are tested in EDS (wafer test) process
3. These parameters indicate inductor current

TYPICAL PERFORMANCE CHARACTERISTICS

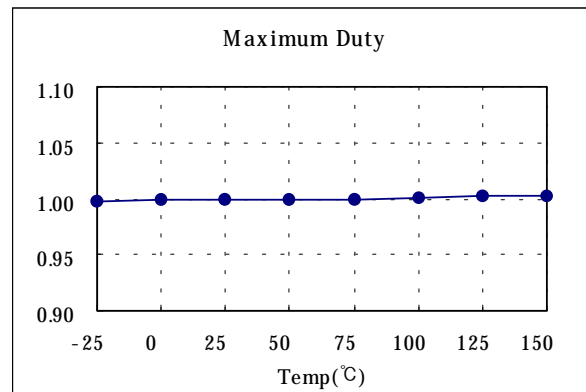
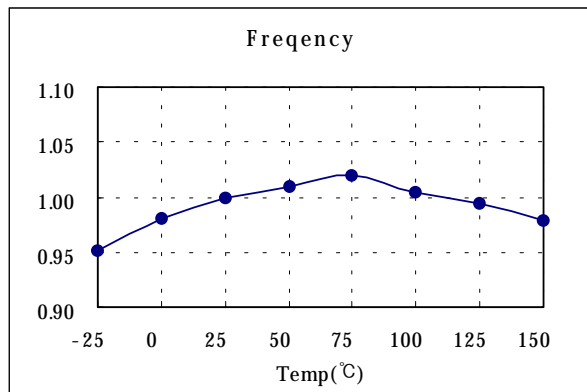
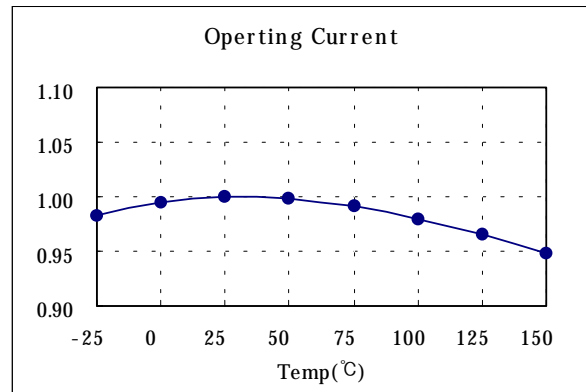
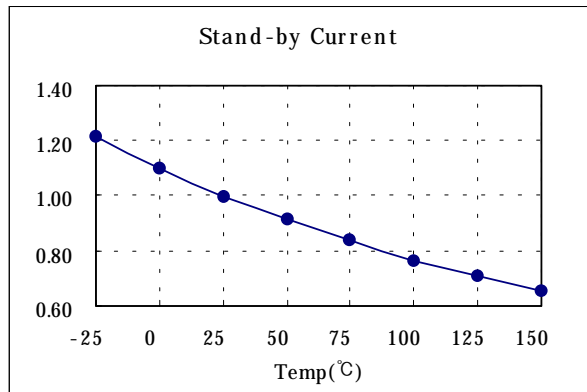
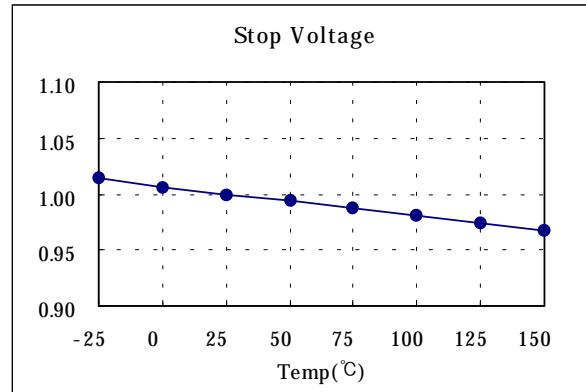
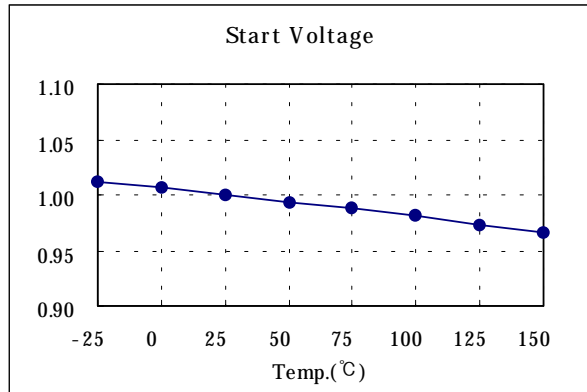

TYPICAL PERFORMANCE CHARACTERISTICS (Continued)

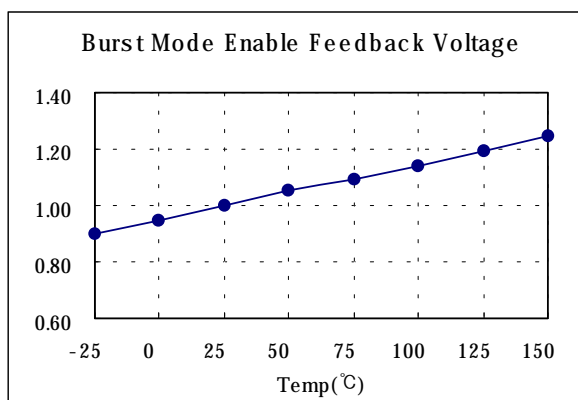
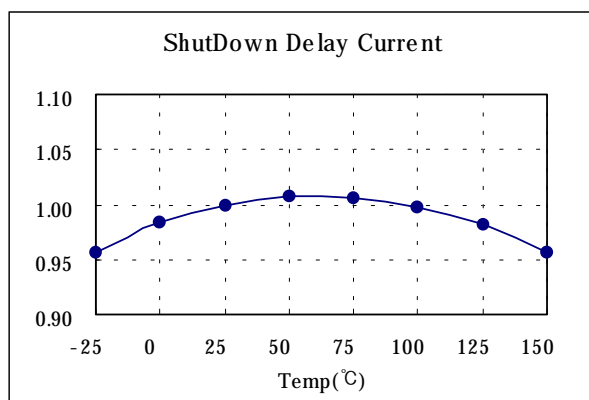
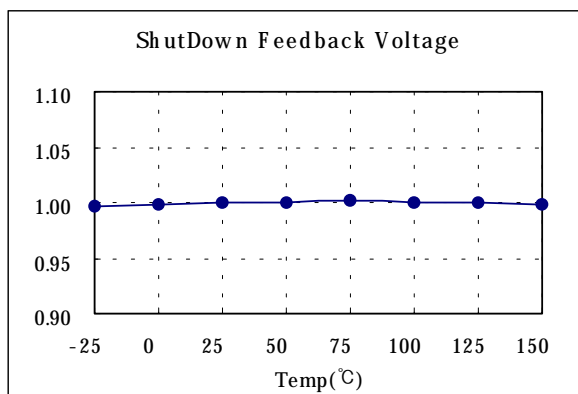
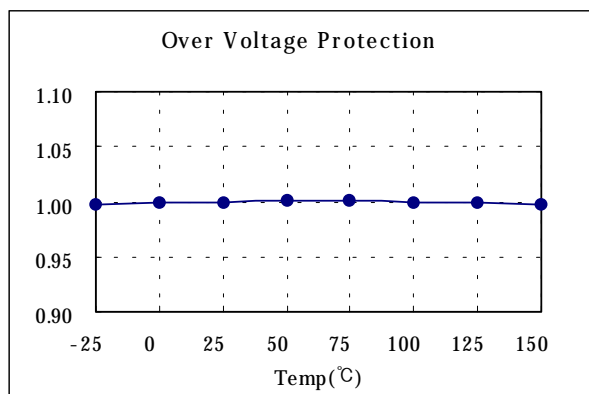
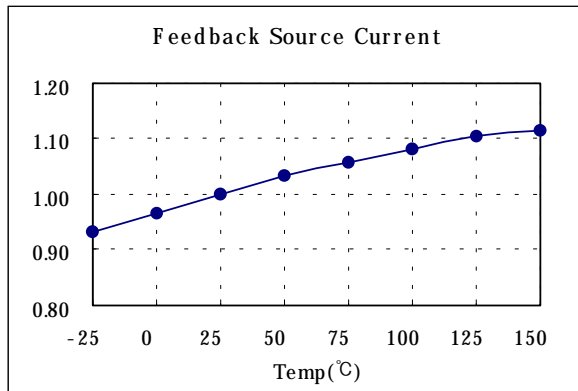
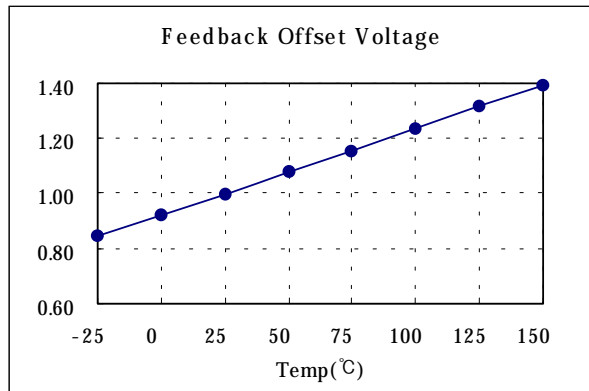

TYPICAL PERFORMANCE CHARACTERISTICS (Continued)

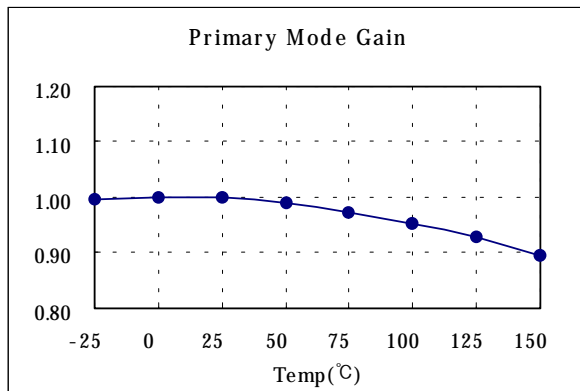
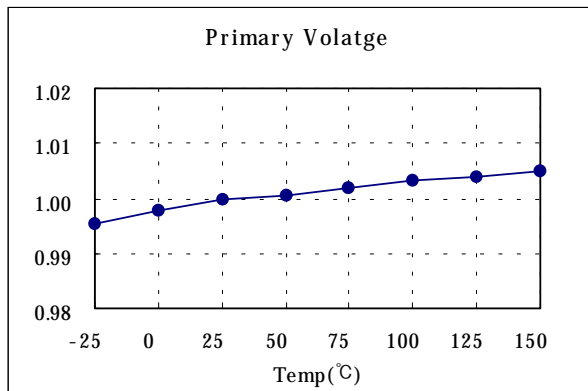
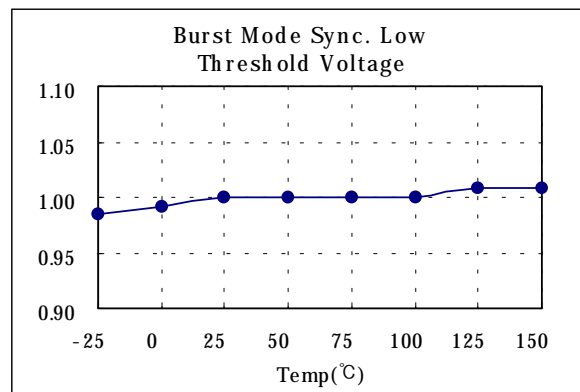
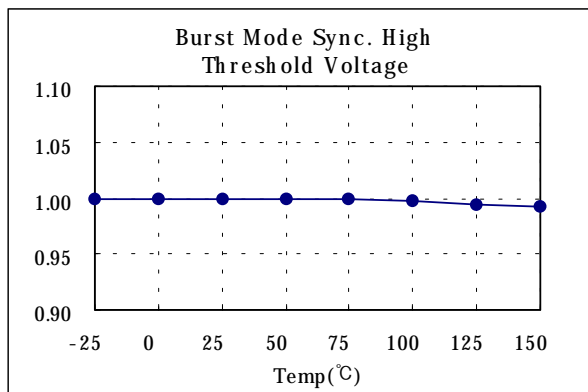
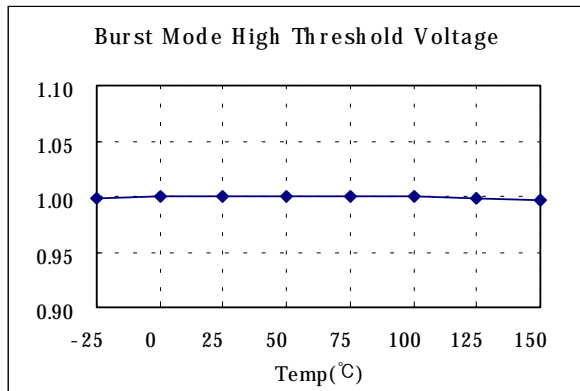
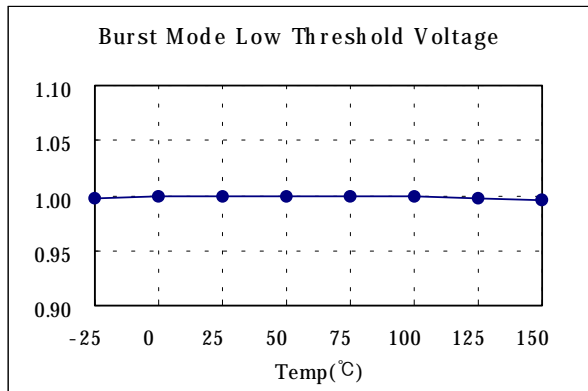



TYPICAL PERFORMANCE CHARACTERISTICS (Continued)

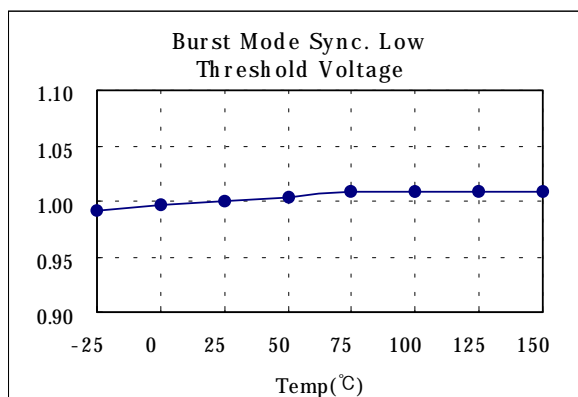
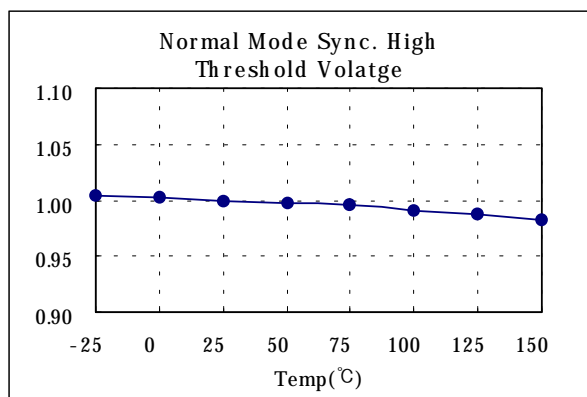
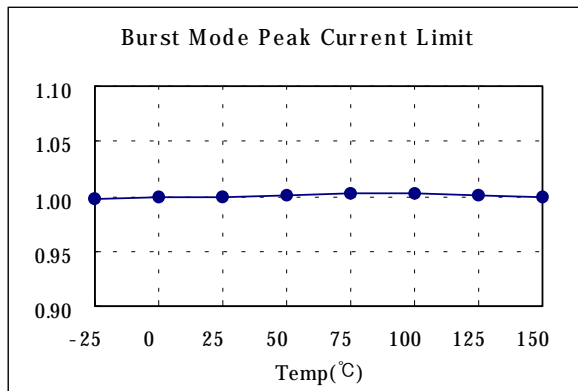
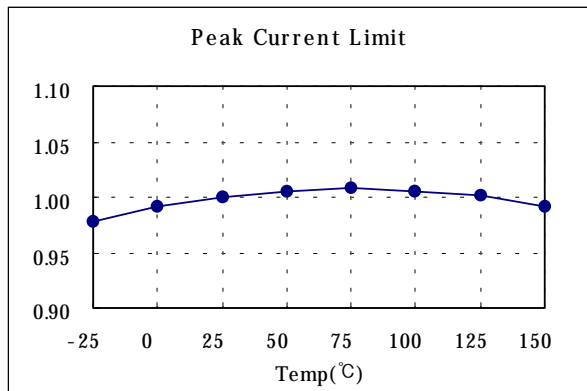

#### **LIFE SUPPORT POLICY**

FAIRCHILD'S PRODUCTS ARE NOT AUTHORIZED FOR USE AS CRITICAL COMPONENTS IN LIFE SUPPORT DEVICES OR SYSTEMS WITHOUT THE EXPRESS WRITTEN APPROVAL OF THE PRESIDENT OF FAIRCHILD SEMICONDUCTOR CORPORATION. As used herein:

1. Life support devices or systems are devices or systems which, (a) are intended for surgical implant into the body, or (b) support or sustain life, and (c) whose failure to perform when properly used in accordance with instructions for use provided in the labeling, can be reasonably expected to result in a significant injury of the user.
2. A critical component in any component of a life support device or system whose failure to perform can be reasonably expected to cause the failure of the life support device or system, or to affect its safety or effectiveness.