



ACS108-6S

AC switch family Transient voltage protected AC Switch (ACS™)

Main product characteristics

$I_{T(RMS)}$	0.8 A
V_{DRM}/V_{RRM}	600 V
I_{GT}	10 mA

- Overvoltage protection by crowbar technology
- High noise immunity - static $dV/dt > 500$ V/ μ s

Applications

- AC ON/OFF static switching in appliances and industrial control systems
- Drive of low power high inductive or resistive loads like:
 - relay, valve, solenoid,
 - dispenser, door lock
 - pump, fan, micro-motor

Benefits

- Needs no external protection snubber or varistor.
- Enables equipment to meet IEC 61000-4-5.
- Reduces component count by up to 80%.
- Interfaces directly with the micro-controller.
- Common package tab connection supports connection of several alternating current switches (ACS) on the same cooling pad.
- Integrated structure based on ASD⁽¹⁾ technology

Order code

Part number	Marking
ACS108-6SA	ACS1086S
ACS108-6SA-TR	ACS1086S
ACS108-6SA-AP	ACS1086S
ACS108-6SN-TR	ACS1086S

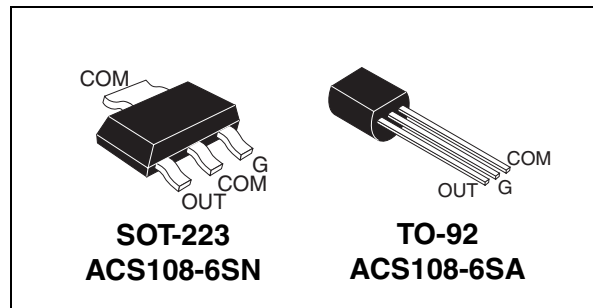

Description

The ACS108-6S belongs to the AC line switch family. This high performance switch can control a load of up to 0.8A.

The ACS108-6S switch includes an overvoltage crowbar structure to absorb the overvoltage energy, and a gate level shifter driver to separate the digital controller from the main switch. It is triggered with a negative gate current flowing out of the gate pin.

Functional diagram

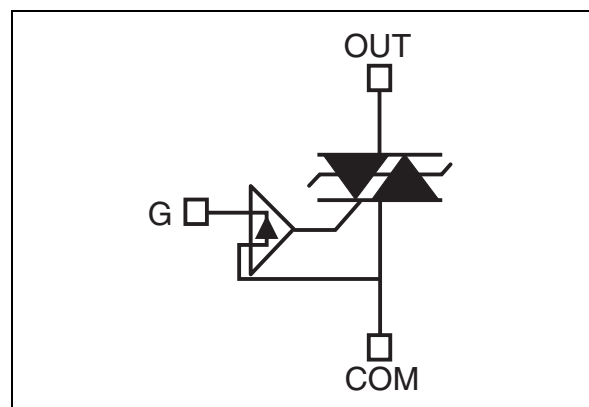

COM Common drive reference to connect to the mains

OUT Output to connect to the load.

G Gate input to connect to the controller through gate resistor

1. ASD: Application Specific Devices

TM: ACS is a trademark of STMicroelectronics

1 Characteristics

Table 1. Absolute maximum ratings ($T_{amb} = 25\text{ °C}$, unless otherwise specified)

Symbol	Parameter			Value	Unit
$I_{T(RMS)}$	RMS on-state current (full sine wave)	TO-92	$T_{lead} = 75\text{ °C}$	0.8	A
		SOT-223	$T_{amb} = 75\text{ °C}$		
		TO-92	$T_{amb} = 61\text{ °C}$	0.45	
I_{TSM}	Non repetitive surge peak on-state current (full cycle sine wave, T_j initial = 25 °C)	f = 60 Hz	t = 16.7 ms	7.6	A
		f = 50 Hz	t = 20 ms	7.3	
I^2t	I^2t Value for fusing	tp = 10 ms		0.38	A ² s
di/dt	Critical rate of rise of on-state current $I_G = 2 \times I_{GT}$, tr ≤ 100 ns	f = 120 Hz	$T_j = 125\text{ °C}$	100	A/μs
V_{PP}	Non repetitive line peak mains voltage ⁽¹⁾	$T_j = 25\text{ °C}$		2	kV
I_{GM}	Peak gate current	$t_p = 20\text{ μs}$	$T_j = 125\text{ °C}$	1	A
V_{GM}	Peak positive gate voltage	$T_j = 125\text{ °C}$		10	V
$P_{G(AV)}$	Average gate power dissipation	$T_j = 125\text{ °C}$		0.1	W
T_{stg} T_j	Storage junction temperature range Operating junction temperature range			-40 to +150 -30 to +125	°C

1. according to test described by IEC 61000-4-5 standard and [Figure 16](#)

Table 2. Electrical characteristics ($T_j = 25\text{ °C}$, unless otherwise specified)

Symbol	Test conditions	Quadrant		Value	Unit
$I_{GT}^{(1)}$	$V_{OUT} = 12\text{ V}$, $R_L = 33\text{ Ω}$	II - III	MAX	10	mA
V_{GT}		II - III	MAX	1	V
V_{GD}	$V_{OUT} = V_{DRM}$, $R_L = 3.3\text{ kΩ}$, $T_j = 125\text{ °C}$	II - III	MIN	0.15	V
$I_H^{(2)}$	$I_{OUT} = 100\text{ mA}$		MAX	25	mA
$I_L^{(2)}$	$I_G = 1.2 \times I_{GT}$		MAX	30	mA
dV/dt ⁽²⁾	$V_{OUT} = 67\% V_{DRM}$, gate open, $T_j = 125\text{ °C}$		MIN	500	V/μs
(di/dt) _C ⁽²⁾	Without snubber (15 V/μs), turn-off time ≤ 20 ms, $T_j = 125\text{ °C}$		MIN	0.3	A/ms
V_{CL}	$I_{CL} = 0.1\text{ mA}$, $t_p = 1\text{ ms}$, $T_j = 125\text{ °C}$		MIN	650	V

1. minimum I_{GT} is guaranteed at 10% of I_{GT} max

2. for both polarities of OUT referenced to COM

Table 3. Static electrical characteristics

Symbol	Test conditions			Value	Unit
$V_{TM}^{(1)}$	$I_{TM} = 1.1 \text{ A}$, $t_p = 500 \mu\text{s}$	$T_j = 25 \text{ }^\circ\text{C}$	MAX	1.3	V
$V_{TO}^{(1)}$		$T_j = 125 \text{ }^\circ\text{C}$	MAX	0.90	V
$R_D^{(1)}$		$T_j = 125 \text{ }^\circ\text{C}$	MAX	300	m Ω
I_{DRM} I_{RRM}	$V_{OUT} = 600 \text{ V}$	$T_j = 25 \text{ }^\circ\text{C}$	MAX	2	μA
		$T_j = 125 \text{ }^\circ\text{C}$		0.2	mA

1. for both polarities of OUT referenced to COM

Table 4. Thermal resistance

Symbol	Parameter		Value	Unit
$R_{th(j-l)}$	Junction to lead (AC)	TO-92	60	$^\circ\text{C/W}$
$R_{th(j-l)}$	Junction to tab (AC)	SOT-223	25	
$R_{th(j-a)}$	Junction to ambient	TO-92	150	
		$S = 5 \text{ cm}^2$ SOT-223	60	

Figure 1. Maximum power dissipation vs RMS on-state current (full cycle) **Figure 2. RMS on-state current vs ambient temperature (full cycle)**

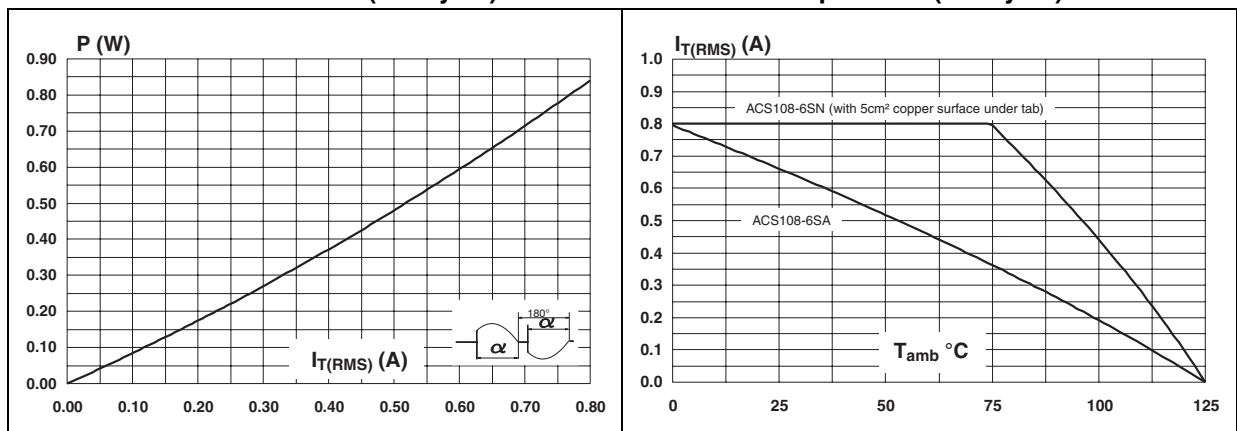

Figure 3. Relative variation of junction to ambient thermal impedance vs pulse duration and package

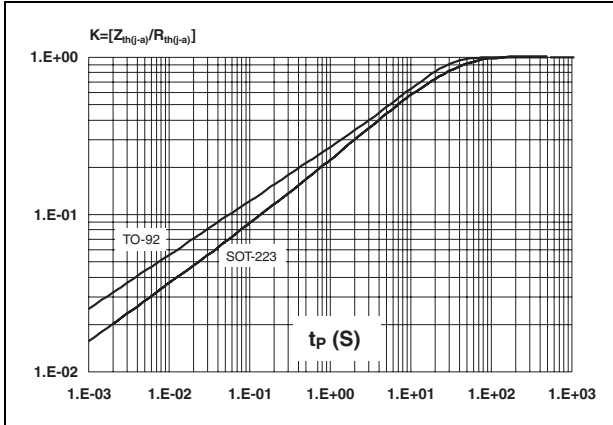

Figure 4. Relative variation of gate trigger current, holding current and latching current vs junction temperature

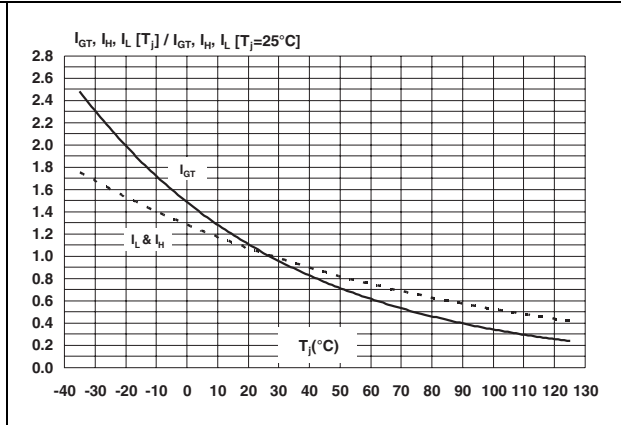

Figure 5. Non repetitive surge peak on-state current vs number of cycles .

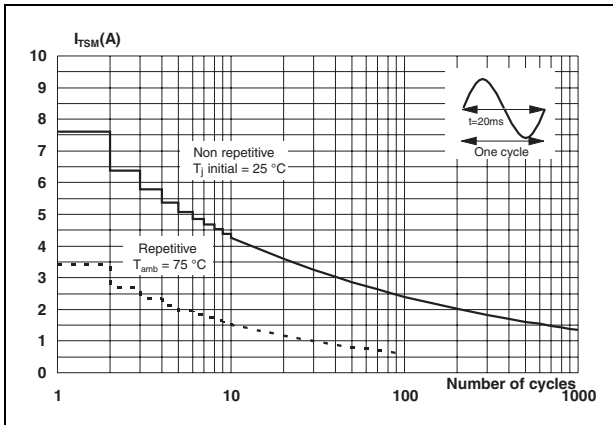

Figure 6. Non repetitive surge peak on-state current for a sinusoidal pulse with width tp < 10 ms, and corresponding value of I²t (Tj initial = 25 °C).

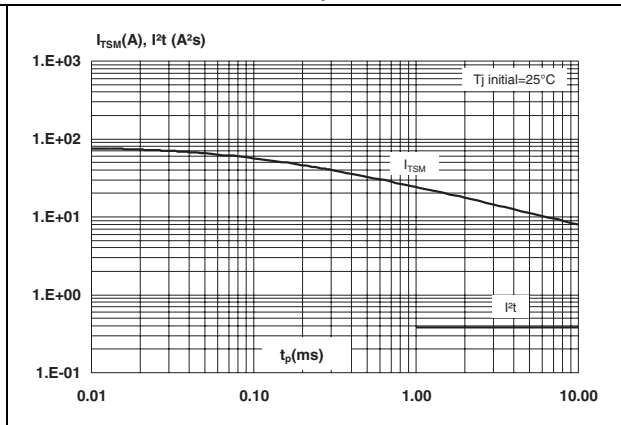

Figure 7. On-state characteristics (maximal values)

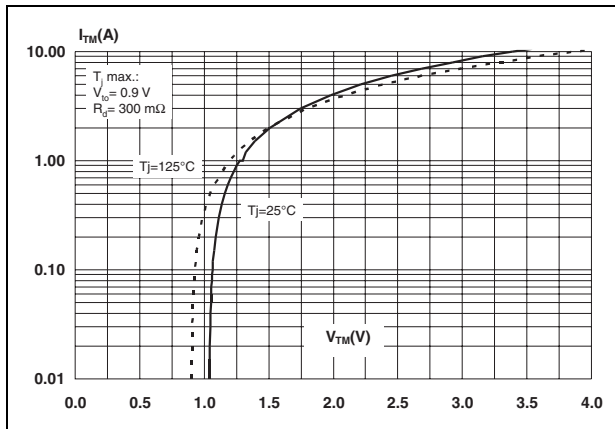

Figure 8. SOT-223 junction to ambient thermal resistance versus copper surface area under tab (PCB FR4, copper thickness 35 μm)

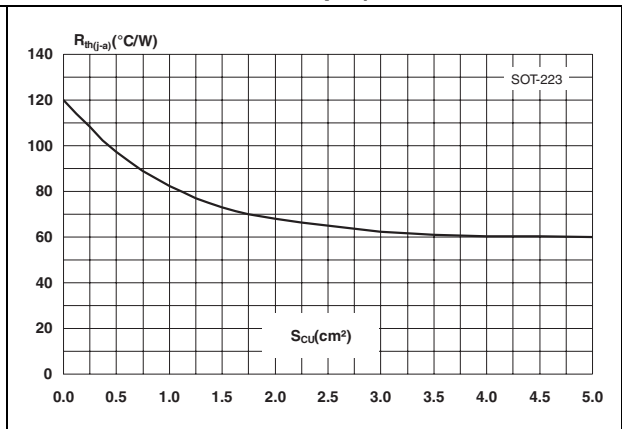

Figure 9. Relative variation of critical rate of decrease of main current $(di/dt)_c$ versus junction temperature

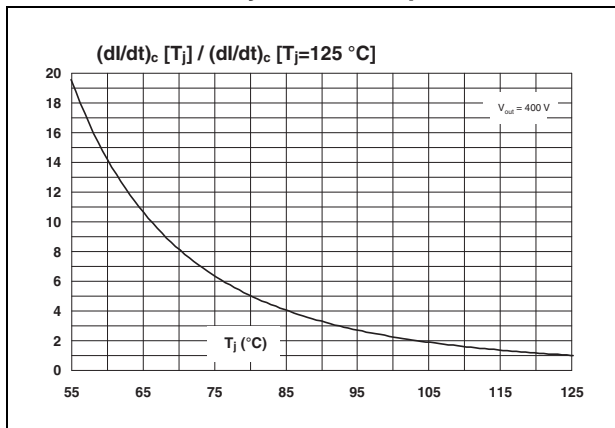

Figure 10. Relative variation of critical rate of decrease of main current $(di/dt)_c$ versus $(dV/dt)_c$, with turn-off time < 20 ms

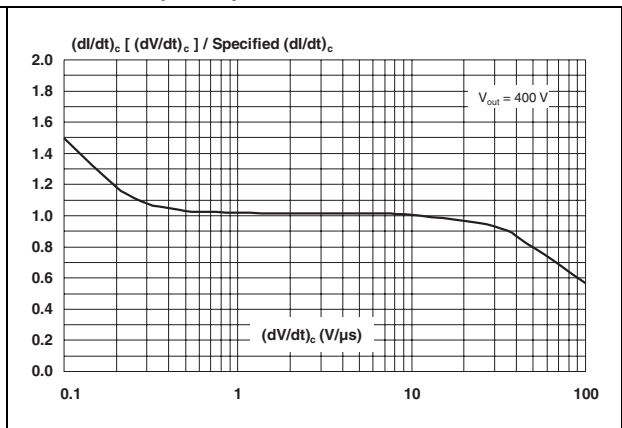

Figure 11. Relative variation of static dV/dt versus junction temperature

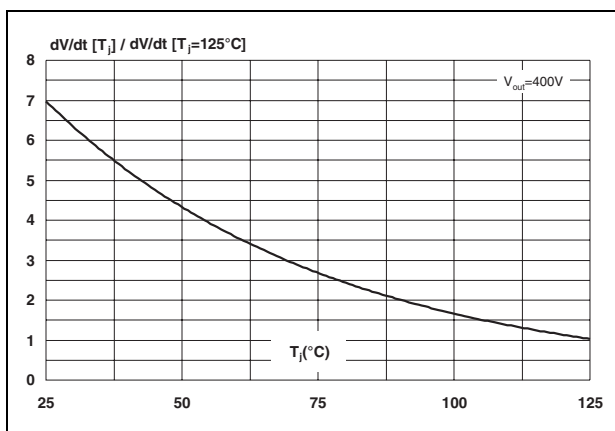
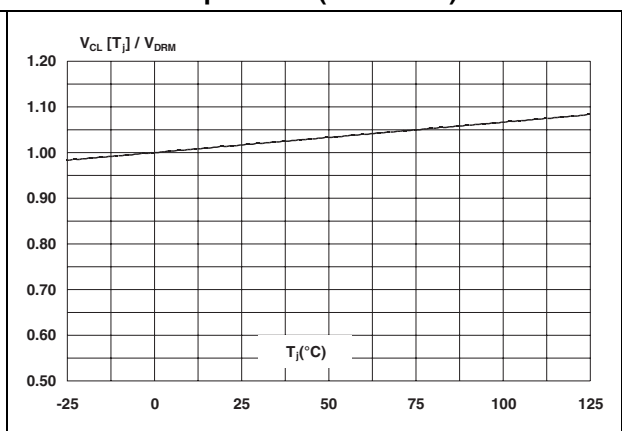

Figure 12. Relative variation of the maximal clamping voltage versus junction temperature (min value)



2 AC line switch - basic application

The ACS108-6S switch is triggered by a negative gate current flowing from the gate pin G. The switch can be driven directly by the digital controller through a resistor as shown in [Figure 13](#).

Thanks to its overvoltage protection and turn-off commutation performance, the ACS108-6S switch can drive a small power high inductive load with neither varistor nor additional turn-off snubber.

Figure 13. Typical application program

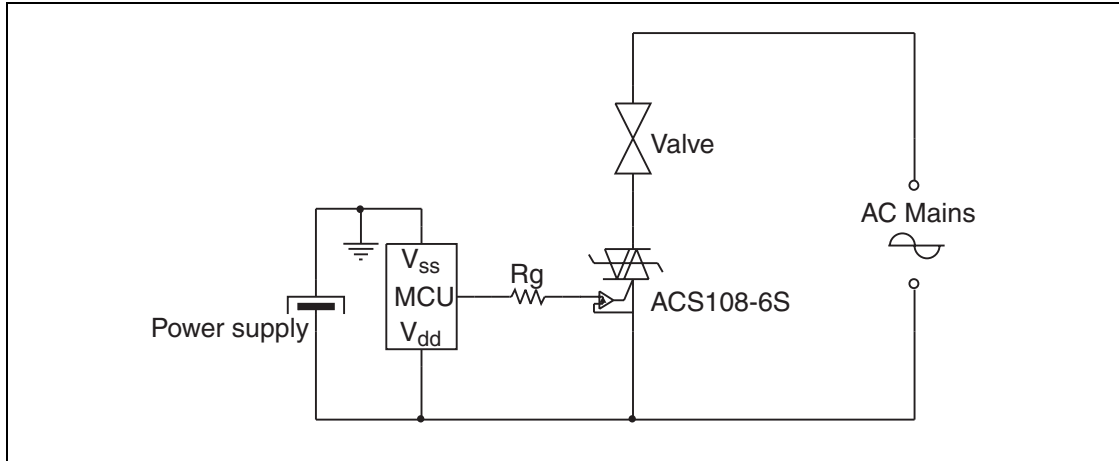

2.1 Protection against overvoltage: the best choice is ACS

In comparison with standard triacs, which are not robust against surge voltage, the ACS108-6S is over-voltage self-protected, specified by the new parameter V_{CL} . This feature is useful in two operating conditions: in case of turn-off of very inductive load, and in case of surge voltage that can occur on the electrical network.

2.1.1 High inductive load switch-off: turn-off overvoltage clamping

With high inductive and low RMS current loads the rate of decrease of the current is very low. An overvoltage can occur when the gate current is removed and the OUT current is lower than I_H .

As shown in [Figure 14](#) and [Figure 15](#), at the end of the last conduction half-cycle, the load current decreases (1). The load current reaches the holding current level I_H (2), and the ACS turns off (3). The water valve, as an inductive load (up to 15 H), reacts as a current generator and an overvoltage is created, which is clamped by the ACS (4). The current flows through the ACS avalanche and decreases linearly to zero. During this time, the voltage across the switch is limited to the clamping voltage V_{CL} . The energy stored in the inductance of the load is dissipated in the clamping section that is designed for this purpose. When the energy has been dissipated, the ACS voltage falls back to the mains voltage value (5).

Figure 14. Effect of the switching off of a high inductive load - typical clamping capability of ACS108-6S

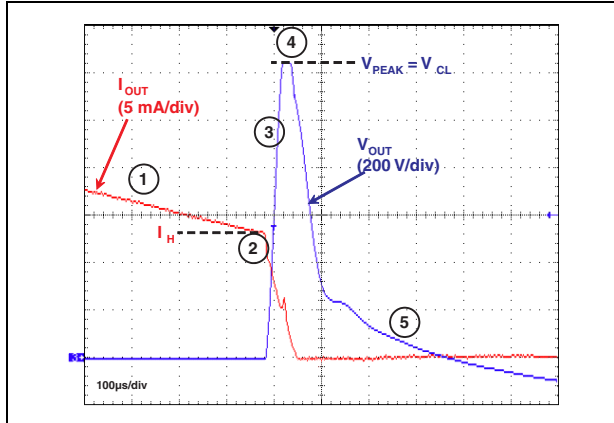
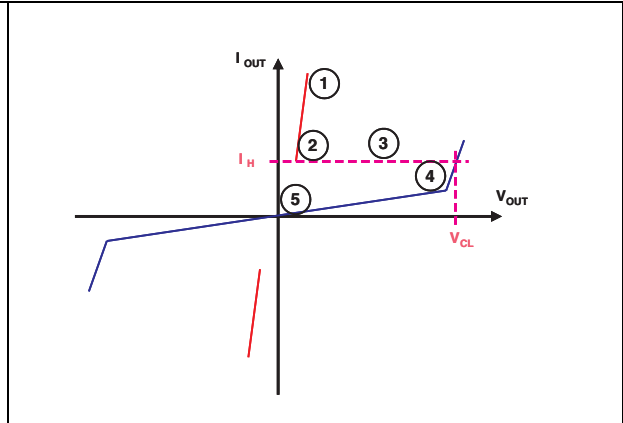

Figure 15. Description of the different steps during switching off of a high inductive load



2.1.2 AC line transient voltage ruggedness

The ACS108-6S switch is able to withstand safely the AC line transients either by clamping the low energy spikes or by breaking over under high energy shocks, even with high turn-on current rises.

The test circuit shown in *Figure 16* is representative of the final ACS108-6S application, and is also used to test the ACS switch according to the IEC 61000-4-5 standard conditions. Thanks to the load limiting the current, the ACS108-6S switch withstands the voltage spikes up to 2 kV above the peak line voltage. The protection is based on an overvoltage crowbar technology. Actually, the ACS108-6S breaks over safely as shown in *Figure 17*. The ACS108-6S recovers its blocking voltage capability after the surge (switch off back at the next zero crossing of the current).

Such non-repetitive tests can be done 10 times on each AC line voltage polarity.

Figure 16. Overvoltage ruggedness test circuit with conditions equivalent to IEC 61000-4-5 standards

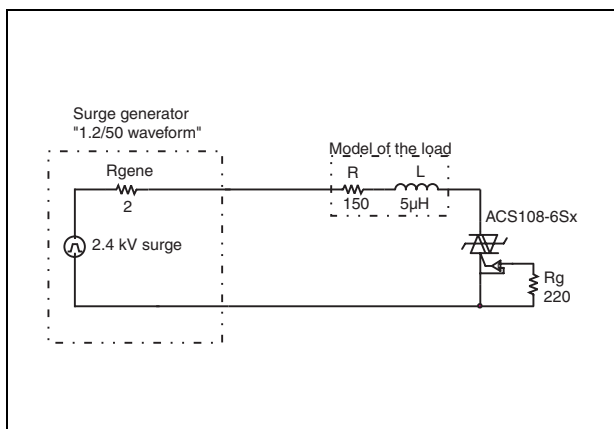
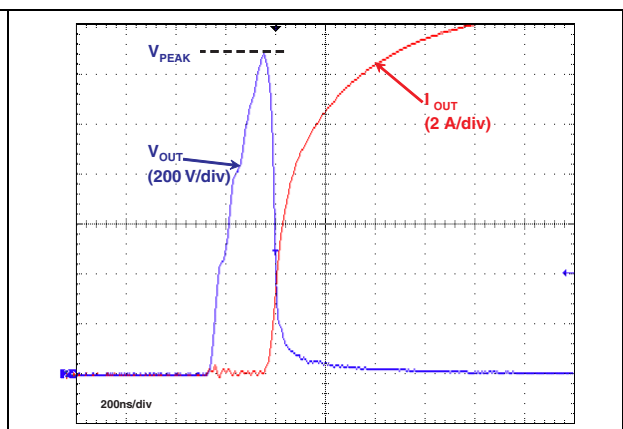
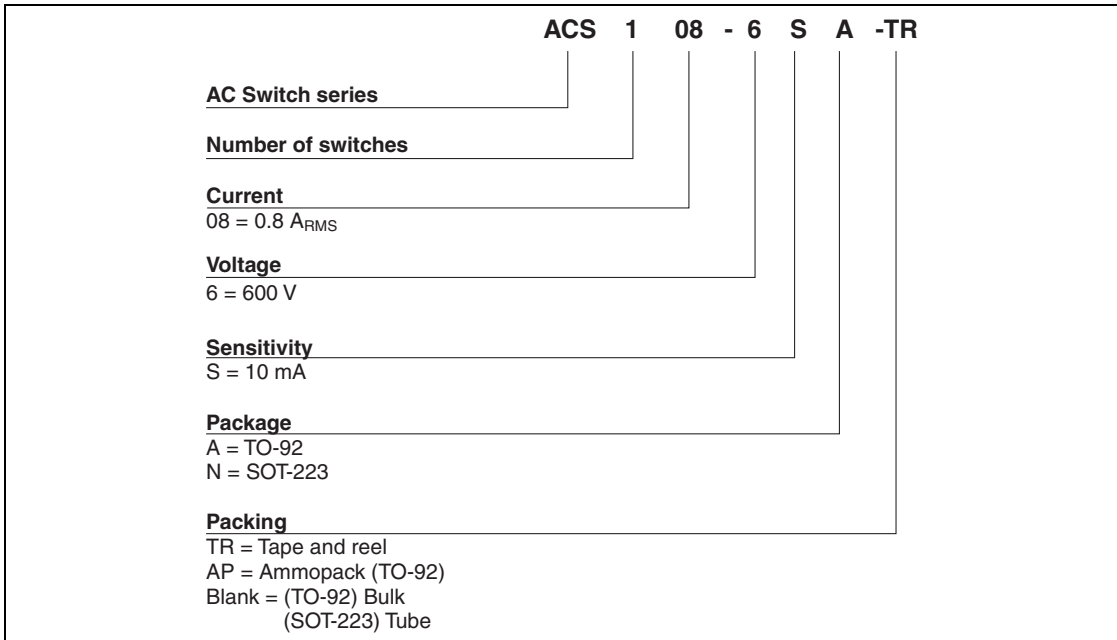

Figure 17. Typical current and voltage waveforms across the ACS108-6S during IEC 61000-4-5 standard test



3 Ordering information scheme



4 Package information

4.1 TO-92 Mechanical data

	DIMENSIONS						
	REF	Millimeters			Inches		
		Min.	Typ.	Max.	Min.	Typ.	Max.
A		1.35			0.053		
B			4.70			0.185	
C		2.54			0.100		
D	4.40			0.173			
E	12.70			0.500			
F			3.70			0.146	
a			0.50			0.019	

4.2 SOT-223 Mechanical data

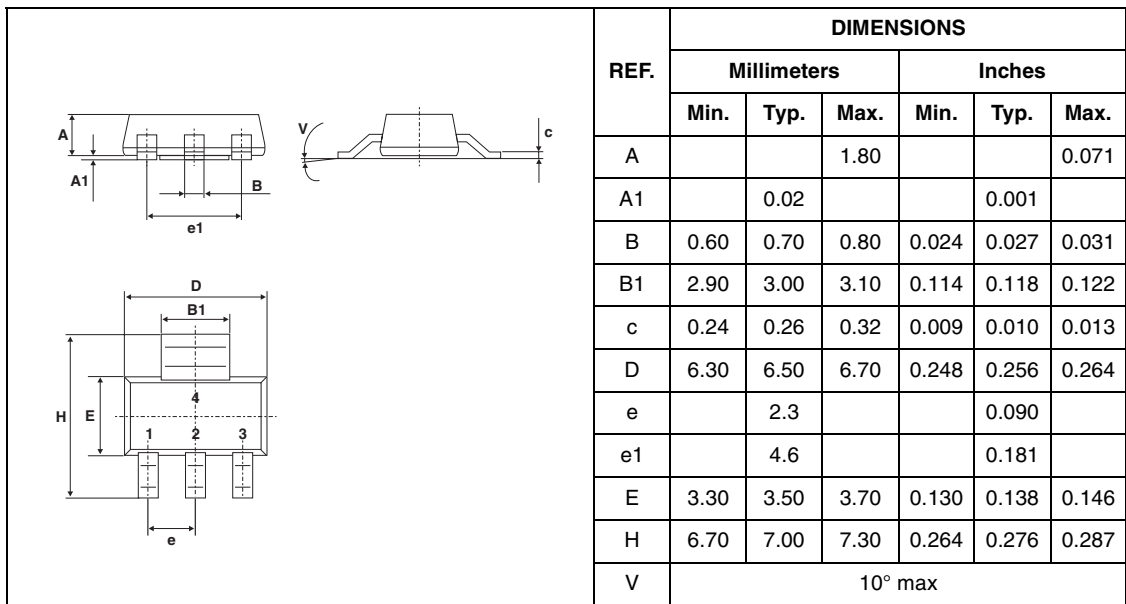
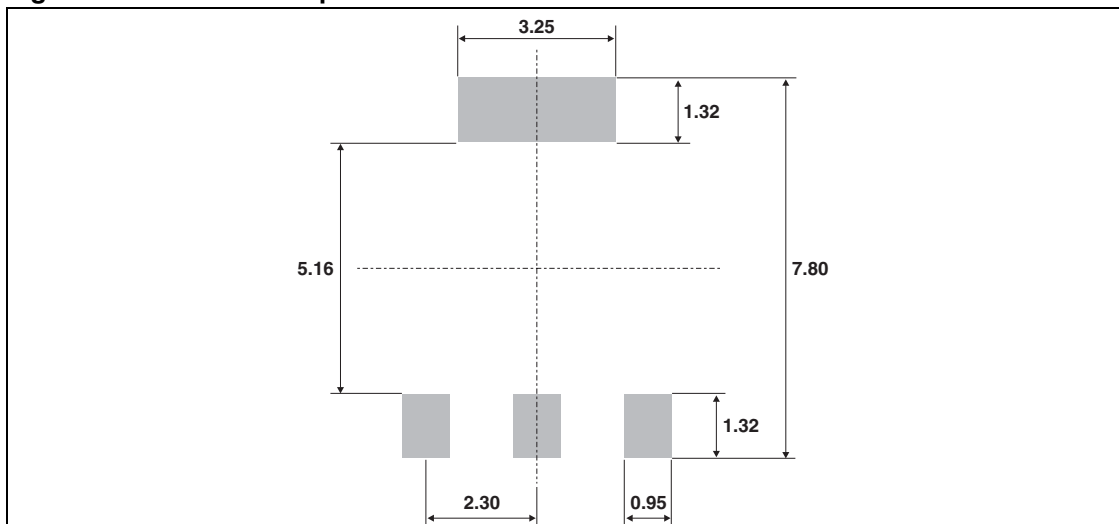

Figure 18. SOT-223 Footprint



In order to meet environmental requirements, ST offers these devices in ECOPACK® packages. These packages have a Lead-free second level interconnect . The category of second level interconnect is marked on the package and on the inner box label, in compliance with JEDEC Standard JESD97. The maximum ratings related to soldering conditions are also marked on the inner box label. ECOPACK is an ST trademark. ECOPACK specifications are available at: www.st.com.

5 Ordering information

Part number	Marking	Package	Weight	Base Qty	Packing mode
ACS108-6SA	ACS1086S	TO-92			Bulk
ACS108-6SA-TR	ACS1086S	TO-92			Tape and Reel
ACS108-6SA-AP	ACS1086S	TO-92			Ammopack
ACS108-6SN-TR	ACS1086S	SOT-223			Tape & reel

6 Revision history

Date	Revision	Changes
05-Jan-2005	1	Initial release.

Information furnished is believed to be accurate and reliable. However, STMicroelectronics assumes no responsibility for the consequences of use of such information nor for any infringement of patents or other rights of third parties which may result from its use. No license is granted by implication or otherwise under any patent or patent rights of STMicroelectronics. Specifications mentioned in this publication are subject to change without notice. This publication supersedes and replaces all information previously supplied. STMicroelectronics products are not authorized for use as critical components in life support devices or systems without express written approval of STMicroelectronics.

The ST logo is a registered trademark of STMicroelectronics.
All other names are the property of their respective owners

© 2006 STMicroelectronics - All rights reserved

STMicroelectronics group of companies

Australia - Belgium - Brazil - Canada - China - Czech Republic - Finland - France - Germany - Hong Kong - India - Israel - Italy - Japan -
Malaysia - Malta - Morocco - Singapore - Spain - Sweden - Switzerland - United Kingdom - United States of America

www.st.com

