



SY8086

High Efficiency 1.4MHz, 1A Synchronous Step Down Regulator Preliminary Spec

General Description

The SY8086 is a high-efficiency 1.4MHz synchronous step-down DC-DC regulator ICs capable of delivering up to 1A output current. The SY8086 operates over a wide input voltage range from 2.5V to 5.5V and integrate main switch and synchronous switch with very low R_{DS(ON)} to minimize the conduction loss.

Low output voltage ripple and small external inductor and capacitor sizes are achieved with 1.4MHz switching frequency. This along with small SOT-23 footprint provides small PCB area application.

Applications

- Portable Navigation Device
- Smart phone
- USB Dongle
- Set Top Box
- Media Player

Features

- low R_{ds(on)} for internal switches (top/bottom): 300mohm/300mohm
- 2.5-5.5V input voltage range
- 1.4MHz switching frequency minimizes the external components
- Internal softstart limits the inrush current
- RoHS Compliant and Halogen Free
- Compact package: SOT23 5-pin

Ordering Information

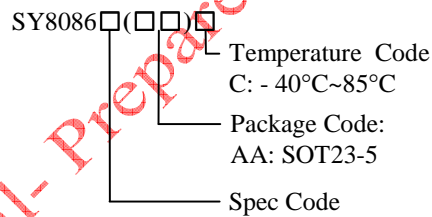

Typical Applications

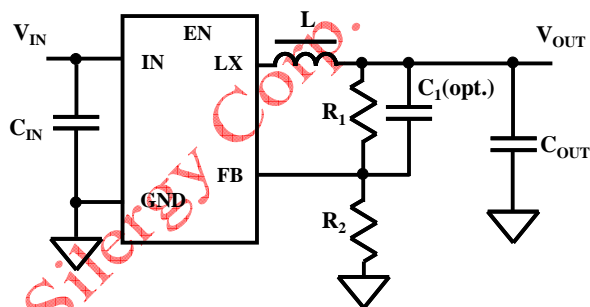

Figure 1

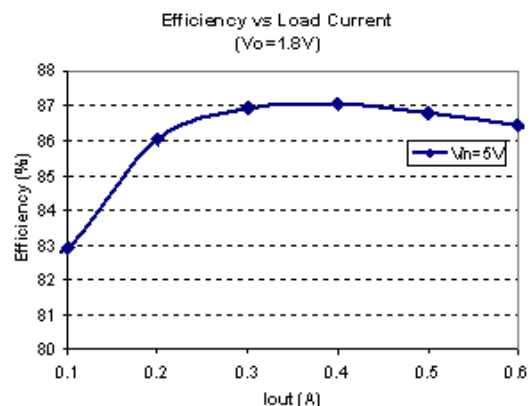
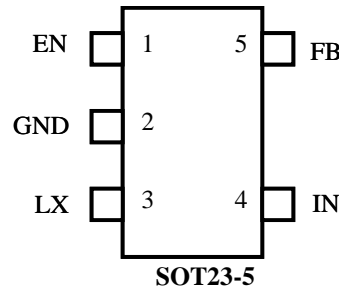

Figure2 Efficiency vs Load Current

Pinout (top view)

Top mark: **BE***xyz* (Device code: BE, *x*=year code, *y*=week code, *z*=lot number code)

Pin Name	Pin Number (SY8086)	Pin Description
EN	1	Enable control. Pull high to turn on. Do not float.
GND	2	Ground pin
LX	3	Inductor pin. Connect this pin to the switching node of inductor
IN	4	Input pin. Decouple this pin to GND pin with at least 1uF ceramic cap
FB	5	Output Feedback Pin. Connect this pin to the center point of the output resistor divider (as shown in Figure 1) to program the output voltage: $V_{out}=0.6*(1+R1/R2)$

Absolute Maximum Ratings (Note 1)

Supply Input Voltage	-----	6.0V
Enable, FB Voltage	-----	$V_{IN} + 0.6V$
Power Dissipation, P_D @ $T_A = 25^\circ C$ SOT-23-5, TSOT-23-5	-----	0.4W
Package Thermal Resistance (Note 2)		
SOT-23-5, θ_{JA}	-----	250°C/W
SOT-23-5, θ_{JC}	-----	130°C/W
Junction Temperature Range	-----	150°C
Lead Temperature (Soldering, 10 sec.)	-----	260°C
Storage Temperature Range	-----	-65°C to 150°C
ESD Susceptibility (Note 2)		
HBM (Human Body Mode)	-----	2kV
MM (Machine Mode)	-----	200V

Recommended Operating Conditions (Note 3)

Supply Input Voltage	-----	2.5V to 5.5V
Junction Temperature Range	-----	-40°C to 125°C
Ambient Temperature Range	-----	-40°C to 85°C



Electrical Characteristics

(VIN = 3.6V, VOUT = 2.5V, L = 2.2uH, COUT = 10uF, TA = 25°C, IMAX = 1A unless otherwise specified)

Parameter	Symbol	Test Conditions	Min	Typ	Max	Unit
Input Voltage Range	VIN		2.5		5.5	V
Shutdown Current	ISHDN	EN=0		0.1	1	μA
Feedback Reference Voltage	VREF		0.58	0.6	0.62	V
FB Input Current	IFB	VFB=VIN	-50		50	nA
PFET RON	RDS(ON),P	SY8086		0.25		Ω
NFET RON	RDS(ON),N	SY8086		0.2		Ω
PFET Current Limit	ILIM	SY8086	1.2			A
EN rising threshold	VENH		1.5			V
EN falling threshold	VENL				0.4	V
Input UVLO threshold	VUVLO				2.5	V
UVLO hysteresis	VHYS			0.1		V
Oscillator Frequency	FOSC	IOUT=100mA		1.4		MHz
Min ON Time				50		ns
Max Duty Cycle			100			%
Thermal Shutdown Temperature	TSD			160		C

Note 1: Stresses listed as the above “Absolute Maximum Ratings” may cause permanent damage to the device. These are for stress ratings. Functional operation of the device at these or any other conditions beyond those indicated in the operational sections of the specifications is not implied. Exposure to absolute maximum rating conditions for extended periods may remain possibility to affect device reliability.

Note 2: θ_{JA} is measured in the natural convection at TA = 25°C on a low effective single layer thermal conductivity test board of JEDEC 51-3 thermal measurement standard. Pin 2 of SOT-23-5/TSOT-23-5 packages is the case position for θ_{JC} measurement.

Note 3: The device is not guaranteed to function outside its operating conditions

SOT23-5 Package outline & PCB layout design

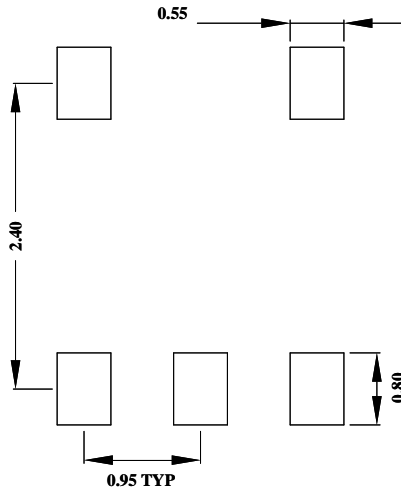

Recommended Pad Layout

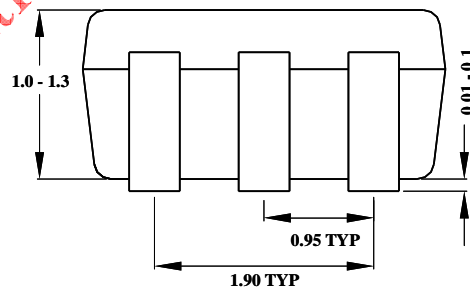
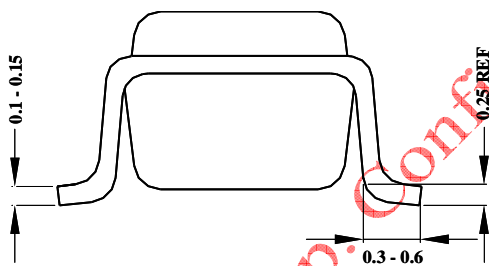
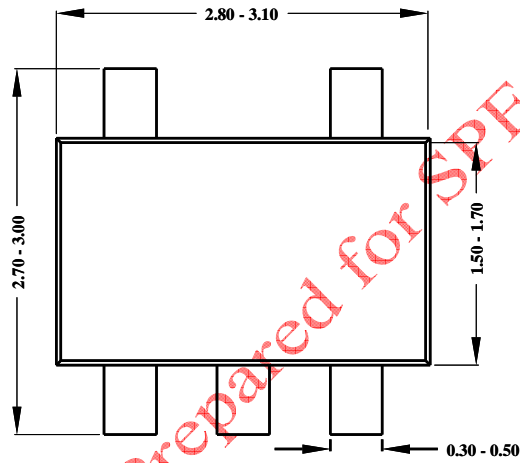

Notes: All dimensions are in millimeters.
All dimensions don't include mold flash & metal burr.